

FV05D/1 -*** (S)

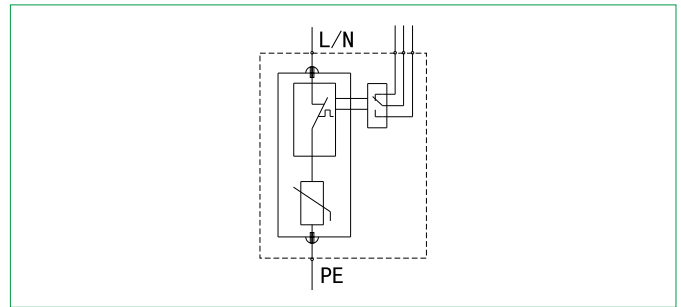

- ◆ Consisting of a base part and MOV pluggable protection modules.
- ◆ For using in the lightning protection zones concept at boundary 1-2.
- ◆ The core parts are metal oxide varistor components with high discharge capacity.
- ◆ Low residual voltage and quick response.
- ◆ Reliable control thanks to Thermo Dynamic Control disconnecter.
- ◆ With remote signaling contact for control device.
- ◆ Fault indication via red mark in the inspection window.
- ◆ Protection mode: L/N-PE.

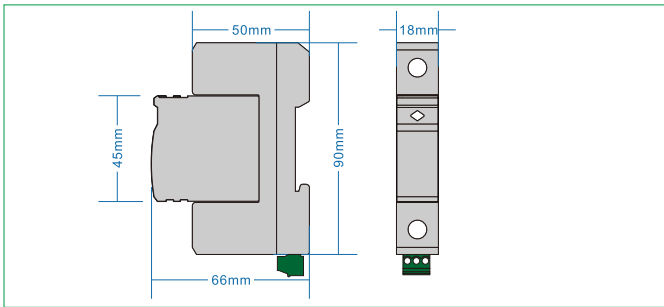

Model No.	FV05D/1-150(S)	FV05D/1-275(S)	FV05D/1-320(S)	FV05D/1-385(S)	FV05D/1-440(S)
Test class IEC/EN/VDE	Class II+III/C+D/ $\overline{T2}$ $\overline{T3}$				
Type of Network	TT, TN, IT				
Protection Mode	L / N - PE				
Nominal voltage 50(60)Hz U_N	110V~	220V~	220V~	220V~	220V~
Rated Voltage (Max. Cont. Operating Voltage) U_c	150V~	275V~	320V~	385V~	440V~
Max. discharge current (8/20 μ s) I_{max}	10kA				
Nominal discharge current (8/20 μ s) I_n	5kA				
Voltage protective level U_p	≤ 0.6 kV	≤ 1.2 kV	≤ 1.5 kV	≤ 1.8 kV	≤ 2.0 kV
Open circuit voltage U_{oc}	10kV				
Response time t_A	≤ 25 ns				
Recommended back-up fuse	16A				
Isolation resistance	$> 10^2$ M Ω				
I/O Connections	Multi core wire: 4mm ² ~25mm ²				
Mounting	35mm Symmetrical rail (EN50022/DIN46277-3)				
Operation temperature range / humidity / altitude	-40°C~+80°C / 30%~90% / 3000m				
Degree of protection	IP20				
Housing material	UL94 V-0				
Disconnection indicator	Mechanical indicator (Green: OK, Red: replace)				
Remote control contact	Optional				

Port definition of remote control contact	Range of signal access		Recommended wire specification	
	AC	$U_{max} \leq 250$ V	Single core wire	Max ≤ 1.5 mm ²
		$I_{max} \leq 0.5$ A		
	DC	$U_{max} \leq 60$ V	Multi core wire	Max ≤ 1.3 mm ²
		$I_{max} \leq 0.1$ A		

Remark: if the model number is without "S", the model is without remote control contact function